



Industry
Canada

Industrie
Canada

Spectrum Management

Ontario Regional Engineering

Evaluation of Electromagnetic Field Intensity in the City of Toronto

Prepared by:
Ben Nguyen, P. Eng.
Sumesh Mohabeer, P. Eng.
Vicky Lai
Elisabeth Lander

June 2002

Acknowledgment

This project could not have been accomplished without the enormous support and encouragement of many people. An extra special thanks to Carl Olsen, Director of Spectrum Management for the Ontario Region, who has been a dedicated supporter from the beginning, allowing us the flexibility and time to undertake such an overwhelming study.

The data necessary for analysis and proving theories could not have been possible without the help of Dave Slingerland, Joe Doria and Watson Reed of the Ontario Region. Many thanks are owed to Dr. Arto Chubukjian and Andrew Lam from DGSE, and Brian Kasper of the DEB Lab in Ottawa for their advice and assistance in the selection of measurement equipment.

A special thank you to Dr. Martial Dufour of the CRC in Ottawa for the use of the Spectrum Explorer and the necessary software, not to mention his expert advice on its theory of operation. Also to Don Paskovich of DGSE, for organizing the equipment loan with CRC, without which none of this would have been possible. Additional thanks to all those who have encouraged and supported the team.

Note to reader: All acronyms have been defined in Appendix F.

Public Summary

Industry Canada is responsible for authorizing radiocommunication stations in Canada to ensure they conform to our policies, regulations and standards. One of the requirements is that all stations must comply with Safety Code 6 (SC 6) guidelines - "*Limits of Human Exposure to Radiofrequency Electromagnetic Fields in the Frequency Range from 3kHz to 300 GHz*". Within the city of Toronto, the Department performed an audit involving the measurement of radio frequency levels at 61 locations. The selected sites were representative of residential, industrial and commercial areas, parks, schools and airports. The measurements were conducted at pedestrian head level (1.75 metres above ground level).

The audit confirmed that all of the measured sites were substantially less than the recommended limits specified in the Safety Code 6 guidelines. The site with the highest radio frequency level, 16 times less than the Safety Code 6 limit, is located between Metro Hall and Roy Thompson Hall. Further analysis of the data determined that the ten sites classified as residential, are on average 7194 times less than the Safety Code 6 limit. The 16 surveyed sites classified as schools and parks are on average 5154 times less, the eight industrial area sites are on average 4464 times, the 26 sites in commercial areas are on average 324 times less, and the site near Pearson International Airport is 125,000 times less than Safety Code 6 limits.

Executive Summary

Industry Canada has always taken an interest in the area of radio-frequency (RF) electromagnetic fields because of our licensing obligation to ensure compliance with Health Canada's Safety Code 6 guidelines - "*Limits of Human Exposure to Radiofrequency Electromagnetic Fields in the Frequency Range from 3 kHz to 300 GHz*". With the increase in the number of antenna installations across Canada, our commitment and involvement has become even more essential. The proliferation of antennas has resulted in the public becoming more aware and concerned regarding RF levels. To fulfill our responsibilities and address the public's growing concern, the Ontario regional office has conducted a study in the City of Toronto, one of the most radio-frequency congested areas in Canada, to determine the current RF ambient levels.

Field measurements were conducted at 61 sites citywide to provide the Department with current data. The selected sites were representative of residential, industrial, and commercial areas, parks, schools and airports. Signals at each site were recorded for a minimum of six minutes per frequency band to capture the variations associated with the local environment, and to comply with the Safety Code 6 guidelines. The measurements were taken 1.75 meters above the ground, at pedestrian head level, for a total of three hours. Because most of the RF energy is concentrated at the lower end of the radio spectrum and due to the frequency limitations of the equipment, measurements were conducted between 150 kHz and 3 GHz.

The study concluded that the maximum measured ambient RF level of the sites surveyed was less than 6% of Health Canada's Safety Code 6 exposure limit for persons not classed as RF and microwave exposed workers (including the general public). This level, 6%, can equally be indicated as about 16 times less than the limit. Measurements were taken at 1.75 m above ground level. The maximum level was measured at a single location within the area between Metro Hall and Roy Thompson Hall. The average of the maximums for the residential areas surveyed was 0.0139% or 7194 times less than Safety Code 6 limits, based on the ten residential sites surveyed; 0.0194% or 5154 times less, for schools and parks (16 surveyed sites); 0.0008% or 125000 times less, near Pearson International Airport (one site surveyed); 0.0224% or 4464 times less, for industrial areas (8 sites surveyed); and 0.3086% or 324 times less, for commercial areas (26 surveyed sites). For data analysis and comparison purposes, if both the Metro Hall and Spadina Parkette measurements were to be removed from the calculation, because of their proximity to the clustered broadcast facilities in the core of Toronto, the average Safety Code 6 percentage for commercial areas would drop dramatically to 0.0556% or 1798 times less than the Safety Code 6 limit. Both the average and maximum levels are well below the current limits recommended by Health Canada.

The analysis of the data also indicated that broadcasting services were the main contributors of the measured signal level at the surveyed sites and ranged from 44% to 71% of this level. Land-mobile services (traditional two-way systems, paging, trunking, and specialized mobile services) contributed 10% to 26% of the measured level. Wireless telephone services (cellular and personal communication systems) ranged from 9% to 24% of the measured level. The total accuracy of these figures is approximately ± 3 dB, due to measurement method and the associated equipment, cable and antenna accuracies.

Table of Contents

	Page No.
Introduction	6
Measurement Activities	8
Site Selection	
Equipment Selection	
Measurement Method and Setup	
Data Analysis	15
Results	17
Conclusions	21
Technical Recommendations	22
Appendix A	
Site Locations and SC6 Values	23
Appendix B	
Example of Site Information and Maps	28
Appendix C	
Antenna and Cable Calibration Charts	29
Appendix D	
Survey Equipment	31
Appendix E	
Photographs of antennas	32
Appendix F	
List of Acronyms	33
Appendix G	
Sites Suggested by City of Toronto officials	34
Appendix H	
Contact List	35
Appendix I	
References	36

Introduction

Over the past decade, the Canadian wireless industry has experienced substantial growth, resulting in increases in the number of antenna installations located on rooftops and towers. Spectrum congestion, rising sensitivity toward existing and proposed antenna towers, and the public's health concerns regarding radio frequency (RF) levels are becoming more apparent across Canada. The Golden Horseshoe Area (GHA)¹ of Ontario, but more specifically the City of Toronto, has one of the most congested radio environments in Canada.

Industry Canada, namely the Ontario Region of Spectrum Management, in its mandate to improve the way it manages its governance of the radio spectrum, has undertaken the task of determining the current RF ambient levels throughout the City of Toronto, through a series of measurements and data analysis. The intent of this study was to audit numerous locations throughout the city to verify that Safety Code 6 (SC 6) exposure limits for persons not classed as RF and microwave workers (including the general public), were met for publically accessible ground level areas. A second objective was to identify whether any one specific category licensee (such as broadcast, cellular, personal communication systems (PCS), local multipoint communication systems (LMCS), paging, aeronautical and land mobile) was a primary contributor to the RF level within the 150 kHz to 3 GHz radio spectrum. The electromagnetic field intensity in the industrial, scientific and medical (ISM) frequency band was also examined to assist manufacturers in designing radio equipment to operate in radio congested environments. In addition, the Department was interested in the relationship between these RF levels and Health Canada's recommended exposure limits².

With this knowledge, departmental officials will be able to more efficiently authorize stations, as well as address an ever growing concern from the public regarding RF energy in their neighbourhoods. In addition, the data gathered will allow the Department to review its application processing procedures with respect to SC 6 levels associated with simple applications, as well as formally respond to City of Toronto officials regarding the issue of field intensity levels at various locations in the city. The Department has agreed to share the results of the survey with the City, the telecommunication's industry, and any other interested party.

The field measurements were conducted at 61 locations within the City of Toronto, 12 of which, listed in Appendix G, were suggested by City of Toronto officials. The locations are representative of residential, industrial, and commercial areas, as well as schools, parks, and airports. The measurement process involved the use of digital analyzers (Spectrum Explorer and Vector Signal Analyzer) to perform band-power measurements on signals received within the 150 kHz to 3 GHz portion of the radio spectrum. The data collected was analyzed, normalized and compared to the limits established by Health Canada to obtain a total Safety Code 6 figure for each location.

1 *Golden Horseshoe Area (GHA) of Ontario is bounded by Newmarket to the North, Niagara to the South, Waterloo to the West and Newcastle to the East.*

2 *Health Canada's Safety Code 6 guideline, Limits of Human Exposure to Radiofrequency Electromagnetic Fields in the Frequency Range from 3 kHz - 300 GHz.*

Prior to performing the measurements, preliminary surveys of the selected locations were conducted with a Narda meter and associated probes, to verify that the recommended SC 6 levels were not exceeded. Due to the probes' limited sensitivity and inaccuracy in registering valid readings for low level signals, additional equipment was used for precise measurements.

The report consists of three main sections pertaining to each step of the study, from measurement activities, data analysis, to conclusions. The measurement activities portion focuses on the site selection criteria, the theory behind the equipment's operation, measurement procedure and methods, data collection, and equipment accuracy. The section dealing with data analysis discusses the various methods of recording the data, and the formulas used in the data analysis to calculate the SC 6 levels at each site, the different methods of determining a maximum versus likely scenario, and a summary of the contributions of the various radio-communication services. The conclusion and technical recommendations section discusses the RF levels at the sites measured in relation to the SC 6 guidelines, proper measurement techniques and comments on the strengths and limitations of the equipment. Attached at the end of the report are several appendices listing the maximum and average recorded levels of each measured site, and calibration curves. Any parties interested in the raw data or the complete program for analysis, should contact the authors. A contact list has been provided in Appendix H.

Measurement Activities

Site Selection

Throughout the City of Toronto, 61 locations were surveyed. The selection process was based on several criteria, firstly sites representing various geographical areas namely residential, industrial, and commercial areas, schools, parks, and airports, and secondly the inclusion of several sites selected by City of Toronto officials, as listed in Appendix G. Roof top locations were not included as part of this study due to equipment transportation difficulties and the complexity of various rooftop antenna configurations.

A preliminary survey was conducted to establish convenient and acceptable measuring locations ensuring minimal reflection and diffraction possibilities at each site. The Narda meter and probe were used as a preliminary check to verify that the locations did not exceed SC 6 levels. However, given the relatively low RF levels at each of the sites, and the sensitivity of the Narda probes, the meter could not accurately register the site's RF energy. During this survey, the exact geographical coordinates were identified with a GPS. Basic details of the site parameters were noted; visible antenna installations, building and tree blockages, and line of sight to the CN Tower at each site. Photographs, maps and observations for one of the surveyed sites is available in Appendix B.

Equipment Selection

The selection of digital analyzers was based on a prior survey conducted by a team of departmental experts from the DEB Lab, DGSE, regional and Toronto district offices, and Acton RSSC, that reviewed available equipment, instrumentation technologies and measurement procedures. The team conducted a small experiment whereby FM and TV broadcast emissions from the CN Tower and First Canadian Place were measured. To compare the different measuring methods, three devices were employed: a Spectrum Explorer using digital signal processor (DSP) technology, developed by the CRC using off-the-shelf hardware from Agilent Technologies and National Instruments, an HP8594E Spectrum Analyzer (analog), and a Narda 8718 Meter with an 8760N E-Field Probe. The team concluded that the digital analyzer was more aptly suited for determining field intensity levels in the survey environment and as a result, it was selected as the primary measuring device.

Historically, to determine RF levels, the carrier power was measured using a swept-tune spectrum analyzer. However, with the advancement of technology, analyzers are now capable of measuring the band-power of a signal within a specified bandwidth. This process involves a newly developed technique of band-power measurement, whereby the area under the signal signature is measured. The received signal is digitized using an analog-to-digital converter (ADC), then analyzed by a digital signal processor (DSP). For the purposes of this study, the HP 89441A Vector Signal Analyzer and Spectrum Explorer, both digital analyzers, were selected. The instruments perform a Fast Fourier Transform (FFT) calculation, essentially measuring the output power of hundreds of narrowband filters with center frequencies distributed across the span of the specified bandwidth and then summing them together.

Ideally, one omnidirectional antenna covering the entire 150 kHz to 3 GHz radio spectrum range would have been preferred, however due to a lack of commercial antenna availability and time constraints, this was not possible. Therefore, the spectrum was divided into four frequency ranges and antennas were selected to cover each range. The omnidirectional Singer 92198-3 antenna was used to receive signals in the 150 kHz to 30 MHz range, the home-built omnidirectional whip antenna for 30 MHz to 80 MHz, the omnidirectional Rhode and Schwarz HK014 for 80 MHz to 1300 MHz and the directional Tecom 201031 log-periodic antenna for the final portion, 1300 MHz to 3000 MHz. Photographs of the Tecom 201031 log-periodic and the Rhode and Schwarz HK014 antennas are listed in Appendix E.

The custom-built whip, Rhode and Schwarz and Tecom antennas were all calibrated internally at the departmental engineering laboratory in Ottawa, while the antenna manufacture calibration chart was used for the Singer antenna. The calibrated curves for each antenna are shown in Appendix C.

Measurement Method and Setup

All field measurements were conducted 1.75 meters above the ground, as recommended in the Safety Code 6 guidelines. Both the whip and Singer antennas were positioned so their feed points were 1.75 meters above the ground, the Rhode and Schwarz HK014 had its phase center 1.75 meters above the ground, and the Tecom 201031 log-periodic was positioned so its feed point and center were 1.75 meters above the ground. Precautions were taken to position the antennas in a manner that would minimize reflections, diffractions, and interactions with people and vehicles, as well as to ensure that within the spatial averaging area, as mentioned in the Safety Code 6 guidelines, the variation of the received signal was less than 0.5 dB.

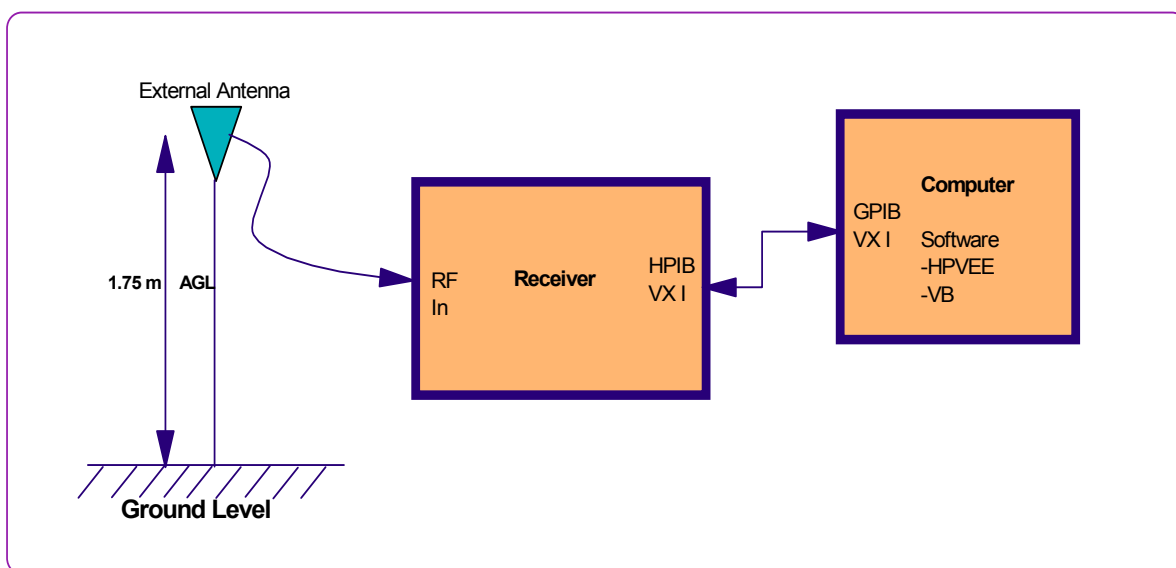

Fi
gu

re No. 01
Equipment and Control Setup

Prior to the measurements, frequency band plans, assignable and assigned channels (with their respective bandwidths), within the 150 kHz to 3 GHz frequency range, were entered into the Spectrum Explorer software program, as scanning lists. These lists contained all the channels to be measured in this study.

The Spectrum Explorer settings were optimized for speed and accuracy, and are shown in Figure No. 02.

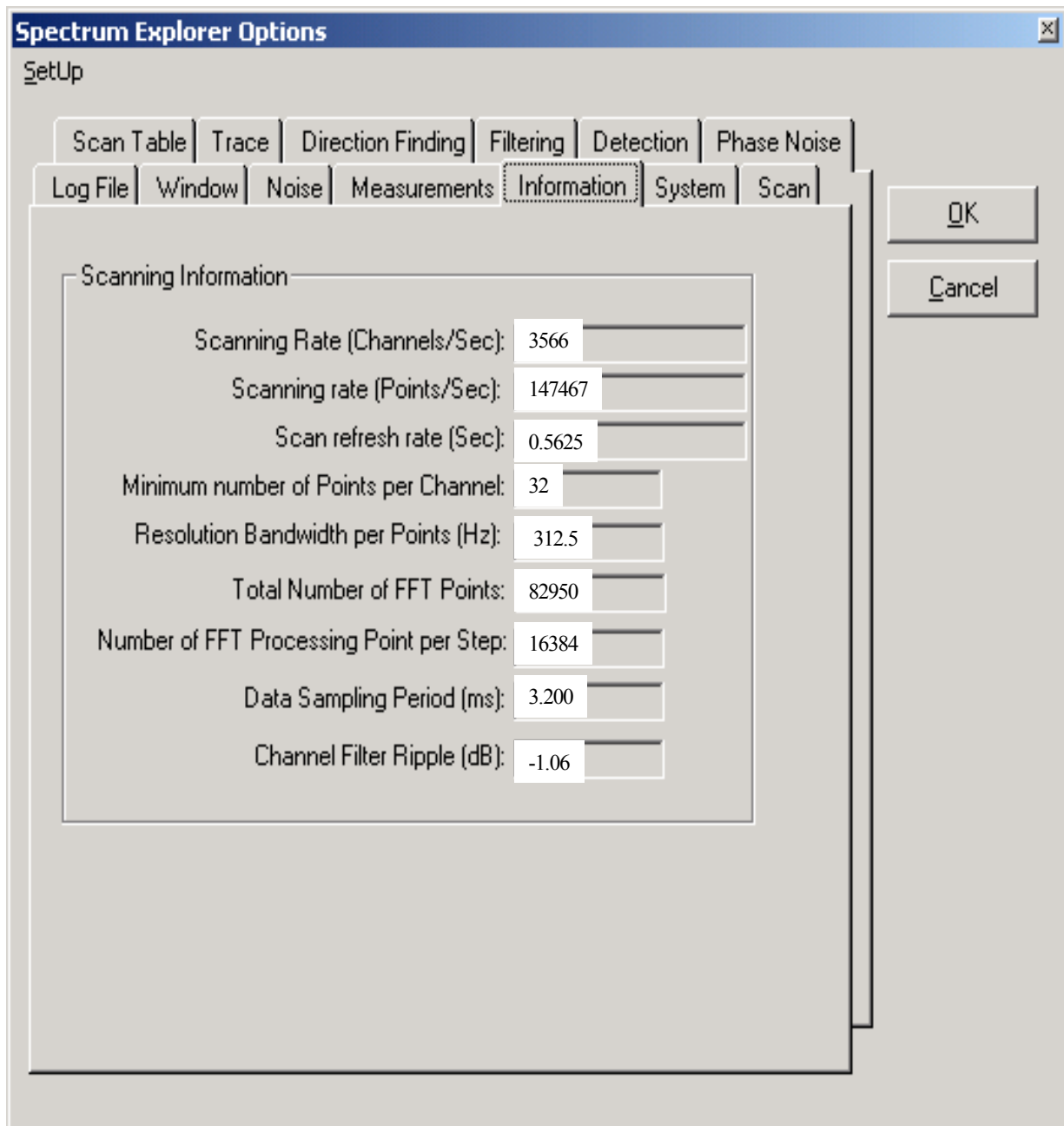

Figure No. 02
Spectrum Explorer Settings

At the outset of each measurement, both the Vector Signal Analyzer and Spectrum Explorer were monitored for overload. If overload was observed on the Vector Analyzer, attenuation was added. If overload was observed on the Spectrum Explorer, adjustments were made by inserting additional attenuation either externally, internally or both. By adding attenuation, the sensitivity of the analyzer is reduced, consequently eliminating low level signals. Because these low level signals are no longer recorded, the measurements will report band-power results that are a little lower than those actually present. However, the eliminated signals are typically 60 dB below, or one million times less than, the measured signal level. Consequently, these adjustments reduced the total energy entering the front end of the analyzer.

The signals at each location were recorded for a minimum of six minutes per frequency band to capture the variations due to the local environment, and to comply with the Safety Code 6 guidelines. All antennas, except for the Singer 92198-3 and the custom-built whip, were rotated 360° to obtain the maximum signal level. The sites were normally monitored for three hours resulting in the collection of approximately one gigabyte of data.

The Vector Spectrum Analyzer logged the signal strength of those received frequencies in the 150 kHz to 30 MHz range. To ensure that the receiver unit was stable before the digitization process took place, a settling time of five milliseconds was selected. The Spectrum Explorer measured those signals within the 30 MHz to 3 GHz frequency spectrum. The Explorer took several milliseconds to complete a sub-band, since it is only capable of digitizing 4.51 MHz of spectrum at once. The sweep time is also dependant on the number of bins (equivalent to the resolution bandwidth of an analog analyzer) selected for each channel. Both analyzers were software controlled by a personal computer that dated and time stamped the logged data.

The Vector Analyzer’s frequency span was sub-divided into eight frequency ranges, accommodating the eight bands of the omnidirectional Singer 92198-3 antenna. The list of frequency sub-bands for the Vector Analyzer is as listed in Table No. 01.

Frequency Sub-Band	Major Types of Services	Antenna used
150 - 300 kHz	Maritime & Aeronautical	Singer 92198-3
300 - 590 kHz	Aeronautical & AM Radio	Singer 92198-3
590 - 1100 kHz	AM Radio	Singer 92198-3
1100 - 2100 kHz	AM Radio & Mixed	Singer 92198-3
2100 - 4100 kHz	Mixed	Singer 92198-3
4100 - 8000 kHz	Mixed	Singer 92198-3
8000 - 15,000 kHz	Mixed	Singer 92198-3
15,000 - 30,000 kHz	Mixed	Singer 92198-3

Table No. 01
List of Frequency Sub-Bands for the Vector Analyzer

To simplify the settings for the Spectrum Explorer, the monitored frequency band (30 MHz to

3 GHz) was divided into smaller sub-bands to accommodate the various receive antennas, types of services and expected receiving signal levels and is listed in Table No. 02.

Frequency Sub-Band	Major Types of Services	Antenna used
30 - 80 MHz	Land Mobile & Television	Whip
80 - 88 MHz	Television Broadcast	HK 014
88 - 108 MHz	FM Radio	HK 014
108 - 136 MHz	Aeronautical	HK 014
136 - 174 MHz	Land Mobile	HK 014
174 - 406 MHz	Television Broadcast	HK 014
406 - 470 MHz	Land Mobile	HK 014
470 - 806 MHz	Television Broadcast	HK 014
806 - 849 MHz	Mobile	HK 014
849 - 902 MHz	Cellular, Trunking, Paging	HK 014
902 - 960 MHz	Trunking, Paging, Fixed links	HK 014
960 - 1300 MHz	Aeronautical	HK 014
1300 - 3000 MHz	PCS, Digital Radio Broadcast, Wireless Cable TV	Tecom 201031

Table No. 02
List of Frequency Sub-Bands for the Spectrum Explorer

Each of frequency sub-band was further divided into frequency channels with fixed bandwidths of 10 kHz, 50 kHz, 100 kHz, etc. A sample of the frequency channels is listed in Table No. 03.

Channel Number	Center Frequency (MHz)	Channel Bandwidth (Hz)	Filter Resolution (Hz)	Minimum Number of Filters
1	88.005	10000	312.5	9
2	88.015	10000	312.5	9
3	88.025	10000	312.5	9
-----	-----	-----	-----	---
299	90.985	10000	312.5	9
300	90.995	10000	312.5	9
301	91.005	10000	312.5	9

Table No. 03
Samples of Monitored Channels

The maximum received signals of the frequency channels from the monitored frequency bands for

several services are shown in Figure No. 03 below.

Figure No.03

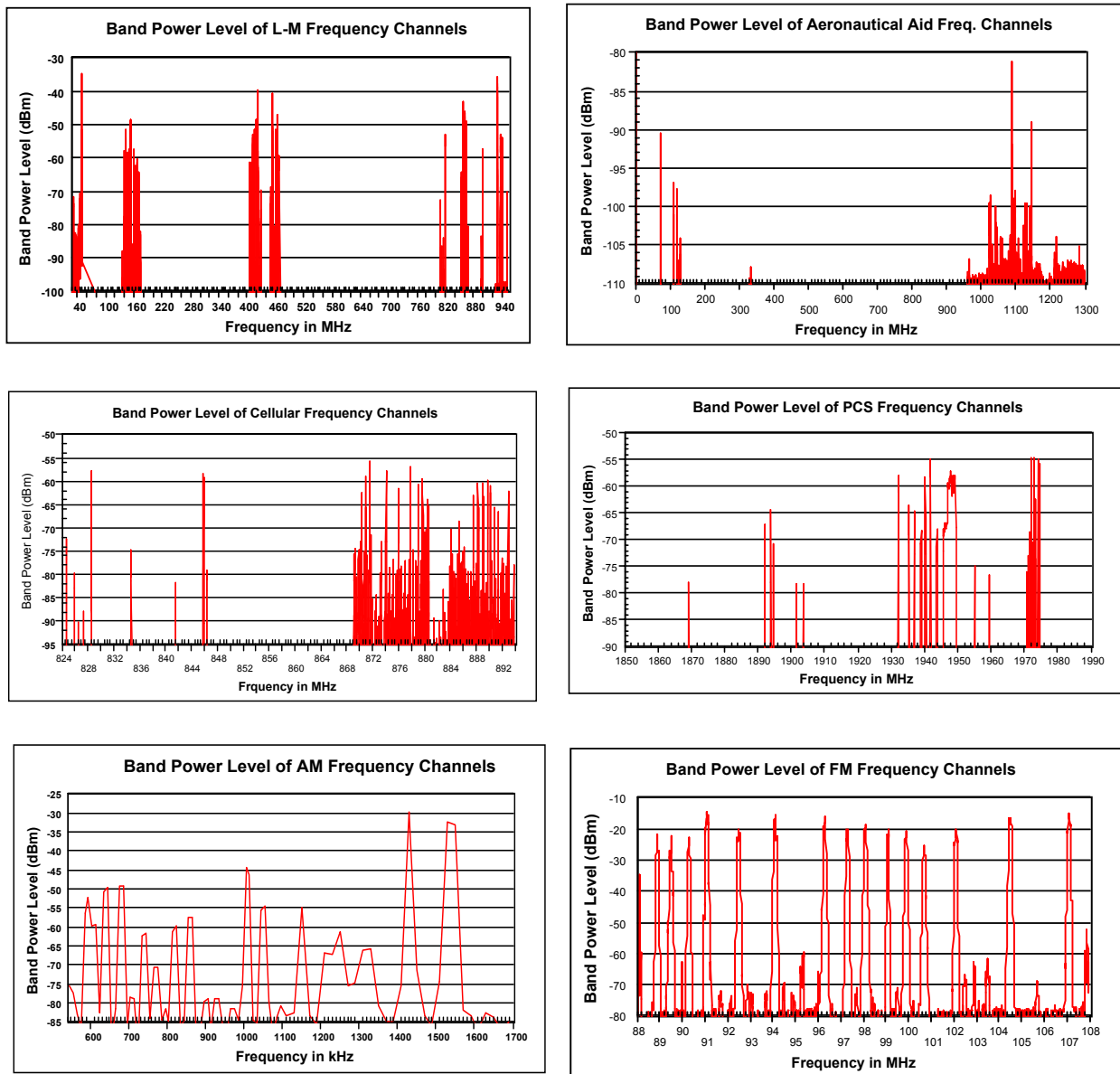

Graphs of Band Power Distribution for Various Services

For the purpose of this analysis, the maximum received signal level recorded within the monitoring period, for each frequency channel, was identified. These levels were converted to an equivalent electric field intensity and normalized with respect to the appropriate Safety Code 6 limit. For each site, the squared normalized electric field intensity values of all the frequency channels were summed to obtain an overall SC 6 figure.

It was assumed that all active frequencies were transmitting simultaneously, which in probability is extremely low. This results in an over-estimation of the actual RF energy present in the surveyed

area. However, it allows the Department to reasonably assure the public that at the 61 locations surveyed, the RF levels are below the calculated figures, at the time of measurement.

Several assumptions were made throughout the course of the measurements and the project itself. One fundamental premise was that the length of time necessary to complete one pass of the frequency band was equal to, or shorter than, the transmitting time of the signals. This meant that all transmitted signals were logged by the system, and none were missed due to short duty cycles. Another crucial assumption was that at the time of measurement, all transmitters were fully operational and at usual power. Lastly, if the addition of attenuation was necessary to counteract overload, the lower level signals that were no longer recorded would not significantly impact the overall results. This is valid, because the eliminated signals are typically 60 dB below, or one million times less than, the measured signal level.

Calibration of the antenna gain, antenna factor and cable losses were all conducted in the DEB Lab in Ottawa. The total measurement and equipment accuracy for this study is ± 3 dB. This figure includes a receiver accuracy of ± 1.0 dB, an antenna gain variation of ± 0.5 dB, cable and connectors uncertainties of ± 0.2 dB, data truncation of ± 0.1 dB and other factors relating to measurement procedures contributed an additional ± 1.0 dB. The uncertainty due to equipment of ± 2.8 dB is arrived at by adding these individual uncertainties results. This is a conservative figure.

Data Analysis

To assist in the analysis of the data, a software program was written. The intent was to interpret the collected data and produce the received signal strengths in dBm for each frequency channel, as well as noting the carrier-to-noise (C/N) ratio. Essentially the program used the received band-power of each frequency channel to calculate the E-field intensity, normalized them to their respective SC 6 limits, and squared the values. Both a maximum and average percentage of SC 6 for each site was obtained by summing the maximum and average figures respectively.

The data collected consisted of the received signal strength, the frequency deviation, and C/N ratio. A sample of this information is outlined in Table No. 04.

Channel Number	Received Level (dBm)	C/N (dB)	Frequency Deviation (Hz)
1	-68.5	25.1	5781
2	-65.3	28.3	6328
3	-52.1	41.5	7800
-----	-----	-----	-----
1001	-45.1	52.1	8713
1002	-35.3	58.3	9725
1003	-48.6	45	8126

Table No. 04
Samples of Collected Data

If the C/N ratio was zero or negative, the channel was considered inactive for that particular sweep, and was not counted in the average. The electric field intensity for each active channel was derived using the following formula:

$$E_c = P_r + AF + C_a + A_t - 13 \quad \text{dBV/m}$$

where

- E_c is the channel electric field intensity in dBV/m
- P_r is the receiving signal level in dBm
- AF is the antenna factor in dB/m
- C_a is cable loss in dB
- A_t is external attenuator in dB, if used

The overall SC 6 value for a monitored site is the sum of the squares of the normalized electric field intensity of all active frequency channels, with respect to the Safety Code 6 limit. This is expressed in the mathematical formula below.

$$\text{SC 6} = \sum (E_c / L_f)^2 \quad (\text{No unit})$$

where

SC 6 is the total Safety Code 6 percentage

E_c is the channel electric field intensity in V/m

L_f is the Safety Code 6 electric field limit for the operating frequency.

The SC 6 figures based on the maximum received signal level of each frequency channel for each site are listed in Appendix A. These values represent a worst case scenario, i.e. all active channels are simultaneously transmitting during the monitoring period.

A “pass” method was used to show a more likely scenario. The SC 6 value for each site was calculated by summing the squares of the normalized electric field intensity values of each active channel in the sub-band, per sweep. Each monitoring period consisted of at least 50 sweeps per sub-band. The maximum and average SC 6 based on “pass” method for each site is shown in Appendix A. It should be noted that longer monitoring periods would have increased the accuracy of the maximum level of non-ionizing radiation and provided a better time average figure for the site. However, due to the numerous sites and the project’s time frame, each site was monitored for approximately three hours.

Several assumptions were made throughout the course of the measurements and the project itself. One fundamental premise was that the length of time necessary to complete one pass of the frequency band was equal to, or shorter than, the transmitting time of the signals. This meant that all transmitted signals were logged by the system, and none were missed due to short duty cycles. Another crucial assumption was that at the time of measurement, all transmitters were fully operational and at usual power. Lastly, if the addition of attenuation was necessary to counteract overload, the lower level signals that were no longer recorded would not significantly impact the overall results.

Results

The highest RF level calculated, 1.75 m above ground level, without cross-polarization compensation was 5.63% or 17 times less than SC 6 at the Metro Hall site. The monitoring location was bound by the CBC English program headquarters to the South, Royal Alexandra Theater to the North, Metro Hall building to the West and Roy Thompson Hall to the East. The site is located less than 400 meters from the base of the CN Tower and First Canadian Place, which house most of the television and FM radio transmitters within the city. It was noted that the measured level varied drastically when the position of the receiving antenna was moved. Therefore, the location was monitored on four separate occasions to account for this fluctuation.

The Spadina Parkette registered the second highest measured level. The receive antenna was positioned 1.75 m above ground, in the direct line-of-sight of the CN Tower and First Canadian Place. There was minimal reflection at this site due to the vast open nature of this locale. Photographs, locations and observations were recorded for each site, and a sample is shown in Appendix B.

The third highest measured level recorded 1.75 m above the ground level, was at the Harbour Front, next to the Metro Police station. A significant contributor to the SC 6 level at this site was the AM broadcasting service, due to the proximity of AM radio transmitters located on Toronto Island, directly across Lake Ontario. Other FM and TV broadcasting signals were partially blocked by the highrise buildings surrounding the measuring position.

The average and maximum Safety Code 6 percentages of the locations surveyed 1.75 m above ground level, are summarized in Appendix A. The locations measured throughout the City are graphically displayed using the maximum SC 6 percentages, in Figures No. 04 and No. 05.

Each location's RF field intensity was analyzed to determine the contributions from various radiocommunication services, namely broadcast, cellular, PCS, LMCS, paging, land mobile and aeronautical. All SC 6 levels at the surveyed sites were significantly lower than the guideline exposure limits³, 1.75 m above the ground level. Generally, the major contributors to the SC 6 values at each of the surveyed sites were broadcasting services (AM, FM, and television) ranging from 44% to 71% of the measured level, depending on surrounding area of the test sites. Land-mobile services including two-way, paging, trunking, etc. contributed approximately 10% to 26% of the measured level. Wireless telephone services (PCS & Cellular) contributed about 9% to 24% of the measured level. Aeronautical services contributed 12% of the measured level near Pearson International Airport, but very little elsewhere.

³ Safety Code 6 guideline, *Limits of Human Exposure to Radiofrequency Fields in the Electromagnetic Frequency Range from 3 kHz - 300 GHz*.

However, depending on the proximity of the radio-communication transmitters to the receiving test antenna, their contribution to the measured level may be significantly higher. For example, at the Lawrence Avenue East & Don Mills Road (site No.29) the major contributor (65% of the total measured level) was a mobile signal operating on 157.830 MHz with a level of 0.09588% or 1043 times less than the SC 6 limit.

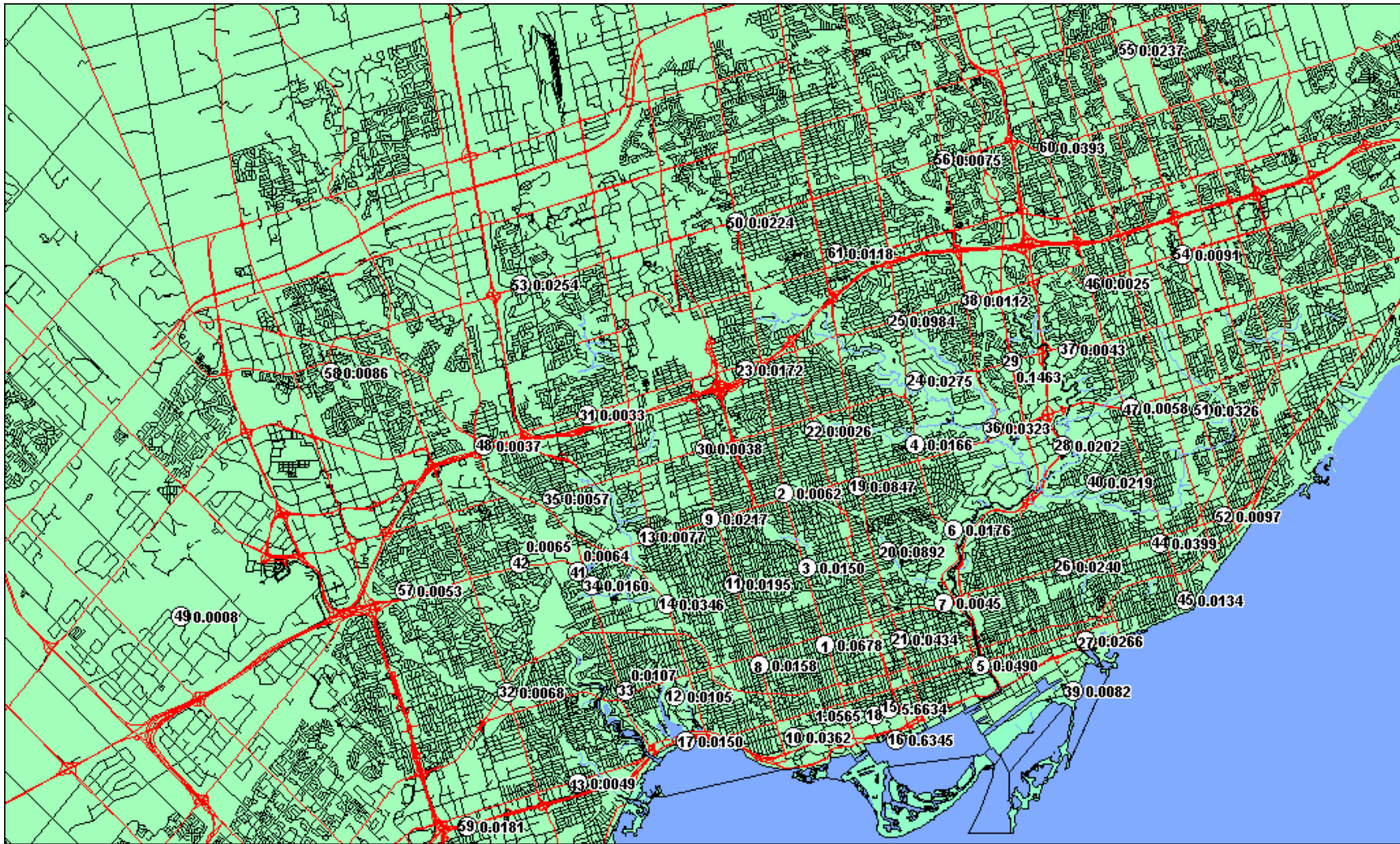

Figure No. 04
Normalized SC6 Levels Recorded
Based on the Maximum Received Signal (Percent of Limit)



Figure No. 05
Normalized SC 6 Levels Recorded
Based on the Maximum Received Signal in Downtown Toronto (Percent of Limit)

Conclusions

The survey, measuring the electromagnetic field intensity levels from 150 kHz to 3 GHz at selected locations, identified that public, accessible locations on ground level (1.75 m above the ground) are well below the recommended public exposure to non-ionization radiation limits set forth by Health Canada. The maximum SC 6 percentage, based on the maximum measured levels of each frequency, was less than 6% or 16 times less than SC 6 limit, found at ground level at the Metro Hall site.

Based on the sites surveyed, broadcasting services were often the major contributors to the total energy, 1.75 m above ground. Depending on the location and surrounding area of the surveyed sites, broadcast services contributed from 44% to 71% of the total measured level. The combined SC 6 values for land-mobile services, trunking and paging (traditional land mobile frequency bands) services ranged from 10% to 26% of the total measured level. Wireless telephone services (PCS & Cellular) contributed 9% to 24% of the total measured level. Aeronautical navigation aids did not contribute significantly to the overall total at the locations surveyed, except for the locations close to the airport, where their measured level was approximately 12%. Since present RF levels were quite low, the total SC 6 percentage figure of a location was easily influenced by nearby mobile transmitters as witnessed at sites No. 29 and No. 25.

Technical Recommendations

The Spectrum Explorer, although mainly a laboratory instrument, was able to perform the necessary measurements. Its limitations were its physical characteristics which resulted in a lack of portability that prevented measurements from being conducted at locations inaccessible to vehicles. Like all equipment there is always room for improvement to gain efficiency: incorporating receivers, ADC boards and controlled PC on the PCI common bus as a single unit having an industrial frame with an external hard drive to increase speed, robustness and data collection. A wider bandwidth receiver and ADC would speed up the measurements. There is a need to develop additional Spectrum Explorer software to include the following features: GPS positioning recording; an antenna factor and cable loss tables; Safety Code 6 limits; calculation and automatic setting of the necessary monitoring time based on the width of the frequency band and channel bandwidth; an overload handling mechanism to avoid a loss of measuring time and data accuracy; and an automatic data recording threshold based on the highest signal level and desired accuracy.

As antennas do not usually have perfect omni patterns in either the horizontal or vertical planes, it is recommended that the testing antenna be rotated in both axes, when dealing with a known source. A slow continuous rotation or stepped rotation of the receive antenna in the horizontal plane will ensure that maximum signals are received from all directions when measuring unknown sources. A non-metallic platform and remote controlled rotator would help to peak the receiving signal level without concern of human body reflection. The receiving antenna should be as wide-band as possible, robust and finely calibrated.

The connecting cable between the receiver and antenna should be low loss, flexible, double shielded, wide-band and at least fifty feet long to avoid the receiving antenna pattern being influenced by the measuring vehicle or human body. The cable connector must be free of dirt and water before it is attached to the antenna and the receiver. Plastic connector covers may be necessary, especially when measurements are conducted in the winter. A set of external attenuators operating in the frequency range from DC to 50 GHz would be useful when entering the high field environment.

Appendix A
Site Locations and SC 6 Values

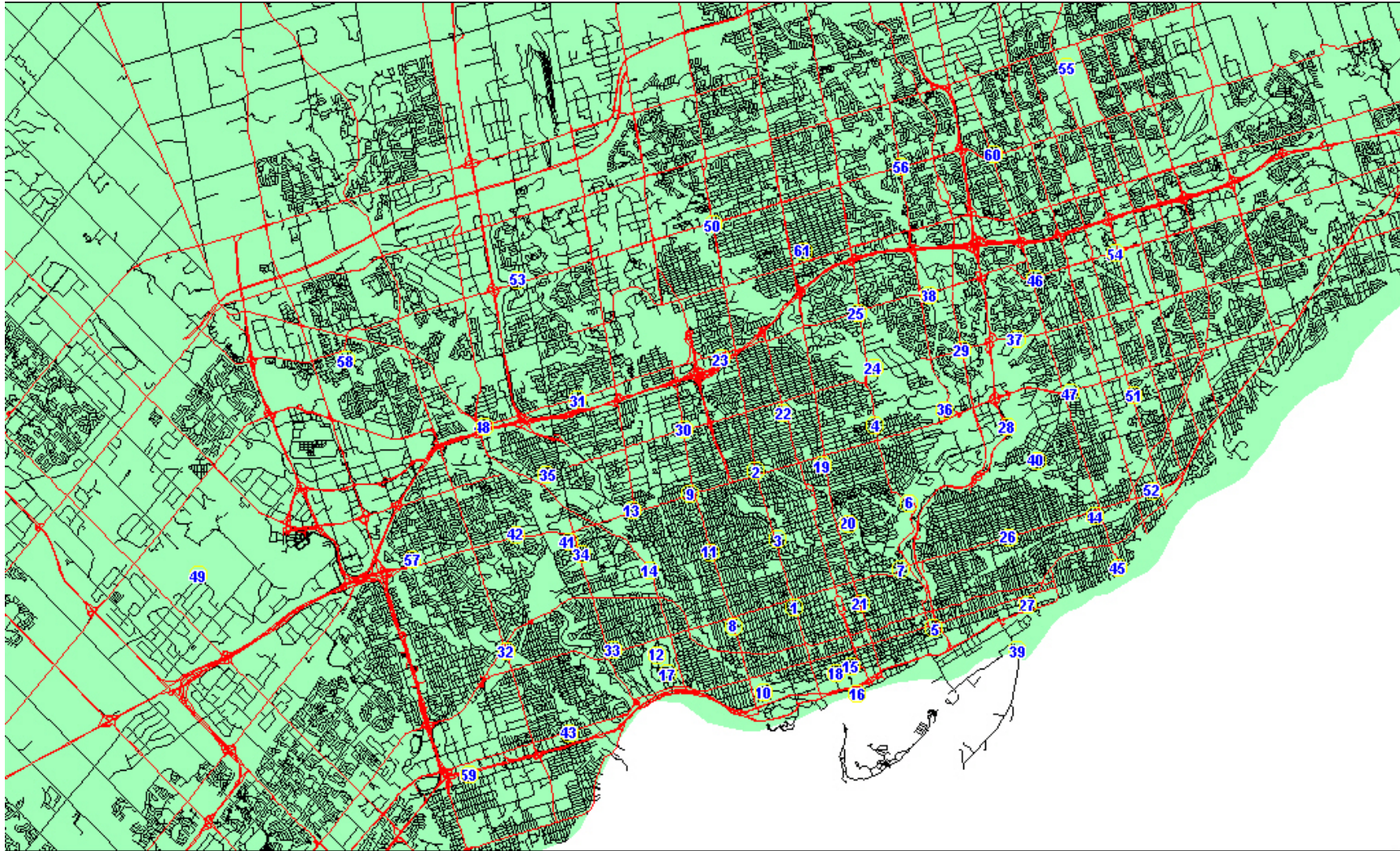

List of SC 6 Percentage for Monitoring Locations Frequency Band Based (Per Frequency Channel)

The following maximum and mean Safety Code 6 percentages have very little probability of actually occurring. These figures are based on the assumption that all active transmitters seen by the receiver during the monitoring period are fully operational and have a 100% duty cycle. The maximum and mean columns represent the sum of the squares of the normalized electric field intensity of each measured frequency channel. For the maximum column, the normalized field intensity is based on the highest measured signal level obtained for each active frequency channel within the measurement period. The normalized field intensity for the mean column is simply the mean average of all the recorded signal levels per active frequency channel.

Site No.	Location	Measurement Date	Frequency Band Based (Per Frequency Channel)	
			Maximum	Mean
1	Bathurst / Bloor	2001-01-08	0.067792%	0.010039%
2	Bathurst / Eglinton	2001-01-08	0.006233%	0.001484%
3	Bathurst / St. Clair	2001-01-18	0.015047%	0.003189%
4	Bayview / Eglinton	2001-01-10	0.016576%	0.006000%
5	Bayview / King	2001-01-10	0.048990%	0.015103%
6	Bayview Ave. / Nesbitt	2001-01-09	0.017632%	0.004487%
7	Bloor / Danforth (CastleFrank)	2001-01-09	0.004502%	0.001361%
8	Dufferin / Bloor	2001-01-17	0.015829%	0.003863%
9	Dufferin / Eglinton	2001-01-18	0.021738%	0.003531%
10	Dufferin / King	2001-01-17	0.036241%	0.010488%
11	Dufferin / St. Clair W.	2001-01-11	0.019467%	0.004865%
12	HighPark Ave. / Bloor St. W.	2001-01-16	0.010468%	0.002206%
13	Keele / Eglinton W.	2000-12-15	0.007744%	0.001397%
14	Keele / St. Clair	2001-01-16	0.034566%	0.008140%
*15	Metro Hall Grounds	2001-06-06	5.633372%	2.110325%
*16	Metro Toronto Police Harbour	2001-06-04	0.634496%	0.161122%
17	Parkside / Lakeshore	2000-11-28	0.015034%	0.003972%
*18	Spadina Ave. Parkette	2001-06-04	1.056497%	0.434146%
19	Yonge / Eglinton	2001-01-12	0.084711%	0.020862%
20	Yonge / St. Clair W.	2000-11-16	0.089187%	0.014767%
21	Yonge / Wellesley St. E.	2000-11-22	0.043431%	0.008457%
*22	Avenue / Lawrence W.	2001-03-22	0.002624%	0.001017%
*23	Bathurst / Wilson	2001-03-21	0.017192%	0.004209%
*24	Bayview / Lawrence W.	2001-03-20	0.027461%	0.003468%
25	Bayview / YorkMills	2001-11-14	0.098395%	0.026796%
26	Coxwell / Danforth	2001-03-13	0.023967%	0.012118%
*27	Coxwell/ Queen St. E.	2001-03-13	0.026632%	0.005672%
*28	DonMills Rd./Don Valley Parkway	2001-03-15	0.020161%	0.006401%
29	DonMills / Lawrence	2000-09-29	0.146325%	0.023981%
*30	Dufferin / Lawrence W.	2000-09-29	0.003799%	0.000821%
31	Highview / Wilson	2001-04-10	0.003254%	0.000802%

32	Islington / Cordova	2001-03-07	0.006833%	0.003320%
*33	Jane / Bloor W.	2001-04-10	0.010744%	0.001805%
34	Jane / Eglinton	2000-11-21	0.016036%	0.006461%
*35	Jane / Lawrence W.	2001-03-12	0.005739%	0.001423%
*36	Leslie / Eglinton E.	2001-03-15	0.032294%	0.004505%
37	Leslie / Talwood Park	2000-09-27	0.004256%	0.000546%
38	Leslie / York Mills	2000-09-28	0.011203%	0.003799%
39	Leslie Pit	2000-09-18	0.008235%	0.005517%
*40	O'Connor Drive / St. Clair E.	2001-03-21	0.021921%	0.009284%
41	Roselawn Public School	2000-09-12	0.006400%	0.001751%
42	Royal York / Eglinton	2001-03-09	0.006482%	0.001688%
43	Royal York / The Queensway	2001-03-07	0.004950%	0.001802%
*44	Victoria Park Rd. / Danforth	2001-03-19	0.039919%	0.013367%
45	Victoria Park Rd. / Queen St	2001-03-19	0.013376%	0.002320%
*46	Victoria Park Rd. / Ellesmere	2001-03-16	0.002539%	0.000697%
*47	Victoria Park Rd. / Eglinton	2001-03-16	0.005848%	0.001275%
*48	Weston / Walsh	2001-03-09	0.003687%	0.000931%
*49	Airport	2001-07-05	0.000763%	0.000248%
50	Bathurst / Finch	2000-11-24	0.022430%	0.011695%
*51	Birchmount / Comstock	2001-05-30	0.032563%	0.006576%
*52	Birchmount / Danforth	2001-05-30	0.009748%	0.006414%
*53	Jane / Finch	2001-06-06	0.025446%	0.000311%
*54	Kennedy / Ellesmere	2001-07-04	0.009126%	0.001874%
*55	Kennedy / Passmore	2000-09-15	0.023705%	0.006270%
*56	Leslie / Finch	2001-06-06	0.007549%	0.002247%
*57	Martin Grove / Eglinton	2001-06-05	0.005322%	0.001983%
*58	Martin Grove / Finch	2001-06-06	0.008575%	0.001831%
*59	The East Mall / The Queensway	2001-06-05	0.018699%	0.002030%
*60	Victoria Park Rd. / Finch	2001-07-03	0.039259%	0.014666%
*61	Yonge / Sheppard	2000-10-19	0.001831%	0.000660%

* The Rhode and Schwarz HK014 antenna was used to receive signals in the 30 MHz to 80 MHz range, instead of the whip.

List of SC 6 Percentage for Monitoring Locations Frequency Band Based (Per Frequency Sub-Band)

The following maximum and mean SC 6 percentages reflect the true radio frequency environment at the time the measurements were conducted. The maximum and mean columns represent the sum of the squares of the normalized field intensity values of each sub-band, per sweep. A sub-band is defined as a frequency span between selected start and stop frequencies. Each span contains many frequencies, up to 20,000 channels. For the maximum column, the normalized field intensity is based on the highest measured level per sub-band. The normalized field intensity for the mean column is simply the mean average of the sub-band's measured signal level. If the length of the monitoring period were extended, the number of sub-band readings would increase resulting in a more accurate representation of the radio frequency environment.

Site No.	Location	Measurement Date	Frequency Band Based (Per Frequency Sub-Band)	
			Maximum	Mean
1	Bathurst / Bloor	2001-01-08	0.014139%	0.008826%
2	Bathurst / Eglinton	2001-01-08	0.002137%	0.001291%
3	Bathurst / StClair	2001-01-18	0.004501%	0.003116%
4	Bayview / Eglinton	2001-01-10	0.007235%	0.004062%
5	Bayview / King	2001-01-10	0.027305%	0.014758%
6	Bayview Ave. / Nesbitt	2001-01-09	0.005719%	0.003537%
7	Bloor / Danforth (CastleFrank)	2001-01-09	0.002118%	0.001106%
8	Dufferin / Bloor	2001-01-17	0.006628%	0.003699%
9	Dufferin / Eglinton	2001-01-18	0.011922%	0.002565%
10	Dufferin / King	2001-01-17	0.016207%	0.010299%
11	Dufferin / St. Clair W.	2001-01-11	0.004912%	0.002554%
12	HighPark Ave. / Bloor St. W.	2001-01-16	0.003247%	0.002165%
13	Keele / Eglinton W.	2000-12-15	0.005349%	0.000840%
14	Keele / St. Clair	2001-01-16	0.013670%	0.005598%
*15	Metro Hall Grounds	2001-06-06	3.332772%	2.105391%
*16	Metro Toronto Police Harbour	2001-06-04	0.218414%	0.157336%
17	Parkside / Lakeshore	2000-11-28	0.006388%	0.003916%
*18	Spadina Ave. Parkette	2001-06-04	0.570755%	0.430239%
19	Yonge / Eglinton	2001-01-12	0.023546%	0.015804%
20	Yonge / St. Clair W.	2000-11-16	0.018045%	0.012654%
21	Yonge / Wellesley St. E.	2000-11-22	0.012695%	0.007569%
*22	Avenue / Lawrence W.	2001-03-22	0.001318%	0.000926%
*23	Bathurst / Wilson	2001-03-21	0.007047%	0.003267%
*24	Bayview / Lawrence W.	2001-03-20	0.005950%	0.003367%
25	Bayview / YorkMills	2001-11-14	0.040746%	0.002684%
26	Coxwell / Danforth	2001-03-13	0.012186%	0.004700%
*27	Coxwell/ Queen St. E.	2001-03-13	0.008554%	0.005147%
*28	DonMills Rd./Don Valley Parkway	2001-03-15	0.009360%	0.005538%
29	DonMills / Lawrence	2000-09-29	0.129526%	0.002839%
*30	Dufferin / Lawrence W.	2000-09-29	0.002102%	0.000714%

31	Highview / Wilson	2001-04-10	0.001188%	0.000553%
32	Islington / Cordova	2001-03-07	0.003159%	0.001739%
*33	Jane / Bloor W.	2001-04-10	0.004922%	0.001700%
34	Jane / Eglinton	2000-11-21	0.004567%	0.002773%
*35	Jane / Lawrence W.	2001-03-12	0.002604%	0.001247%
*36	Leslie / Eglinton E.	2001-03-15	0.007631%	0.003714%
37	Leslie / Talwood Park	2000-09-27	0.001884%	0.000468%
38	Leslie / York Mills	2000-09-28	0.004697%	0.001023%
39	Leslie Pit	2000-09-18	0.006559%	0.005401%
*40	O'Connor Drive / St. Clair E.	2001-03-21	0.013399%	0.009001%
41	Roselawn Public School	2000-09-12	0.001548%	0.001217%
42	Royal York / Eglinton	2001-03-09	0.002561%	0.001274%
43	Royal York / The Queensway	2001-03-07	0.003463%	0.001761%
*44	Victoria Park Rd. / Danforth	2001-03-19	0.011501%	0.007984%
45	Victoria Park Rd. / Queen St	2001-03-19	0.004340%	0.002017%
*46	Victoria Park Rd. / Ellesmere	2001-03-16	0.001537%	0.000537%
*47	Victoria Park Rd. / Eglinton	2001-03-16	0.001873%	0.001059%
*48	Weston / Walsh	2001-03-09	0.001386%	0.000847%
*49	Airport	2001-07-05	0.000422%	0.000238%
50	Bathurst / Finch	2000-11-24	0.011461%	0.003048%
*51	Birchmount / Comstock	2001-05-30	0.013806%	0.006810%
*52	Birchmount / Danforth	2001-05-30	0.003757%	0.002134%
*53	Jane / Finch	2001-06-06	0.015114%	0.007504%
*54	Kennedy / Ellesmere	2001-07-04	0.004951%	0.001644%
*55	Kennedy / Passmore	2000-09-15	0.008126%	0.003064%
*56	Leslie / Finch	2001-06-06	0.003197%	0.002040%
*57	Martin Grove / Eglinton	2001-06-05	0.002301%	0.001398%
*58	Martin Grove / Finch	2001-06-06	0.006201%	0.002168%
*59	The East Mall / The Queensway	2001-06-05	0.013498%	0.001668%
*60	Victoria Park Rd. / Finch	2001-07-03	0.021106%	0.012822%
*61	Yonge / Sheppard	2000-10-19	0.000741%	0.000424%

* The Rhode and Schwarz HK014 antenna was used to receive signals in the 30 MHz to 80 MHz range, instead of the whip.

Appendix B
Example of
Site Information and Maps

Bathurst Street & Bloor Street
Site No. 1
Maximum Safety Code 6 = 0.06779%

Survey
2000

Date : Jan 08

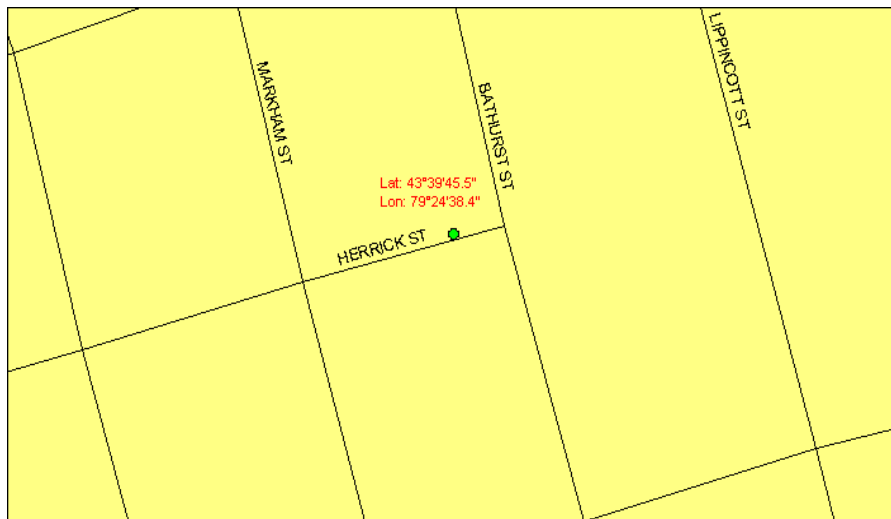

Notes :

1. Residential area in downtown Toronto. Receiving antennas were positioned on the sidewalk across from the track and field yard of the high school. Measurements were taken in the rain, in the morning.
2. The CN Tower and First Canadian Place are visible from the monitoring site.

Appendix C
Antenna and Cable Calibration Charts

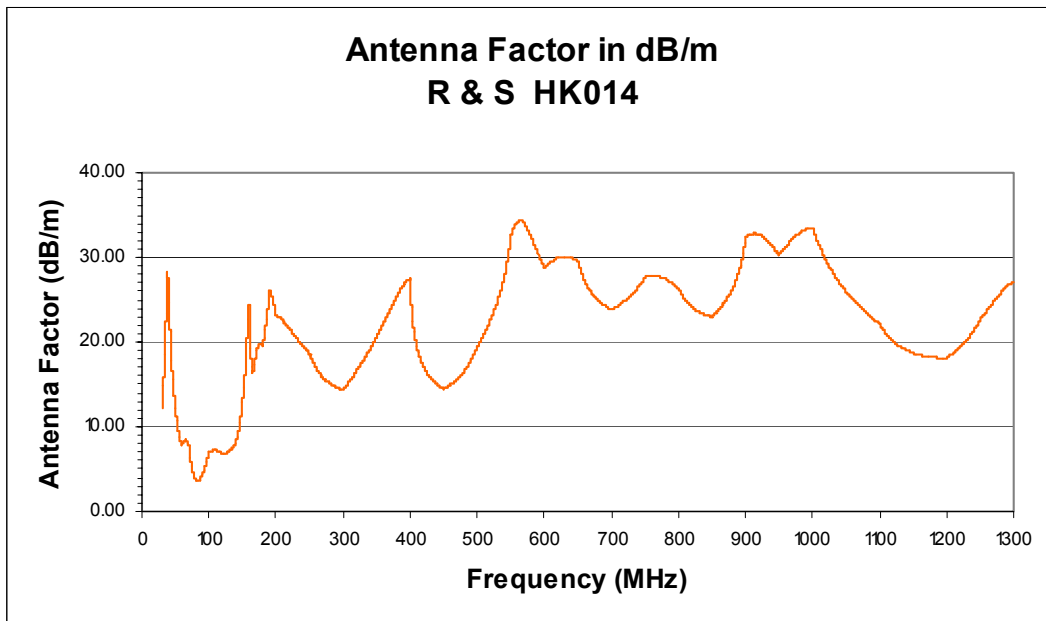
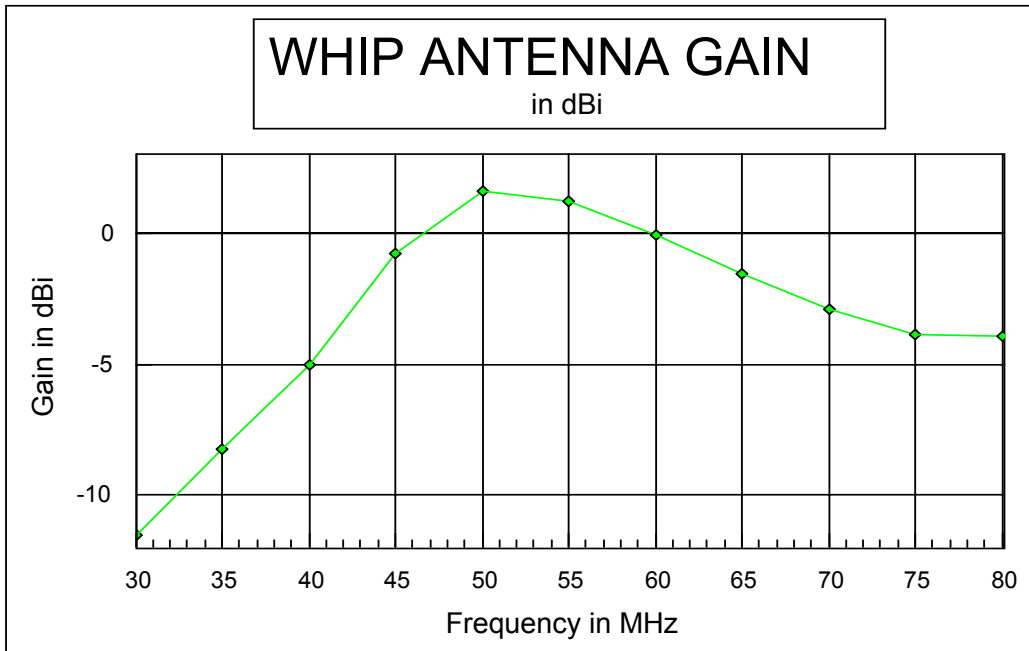

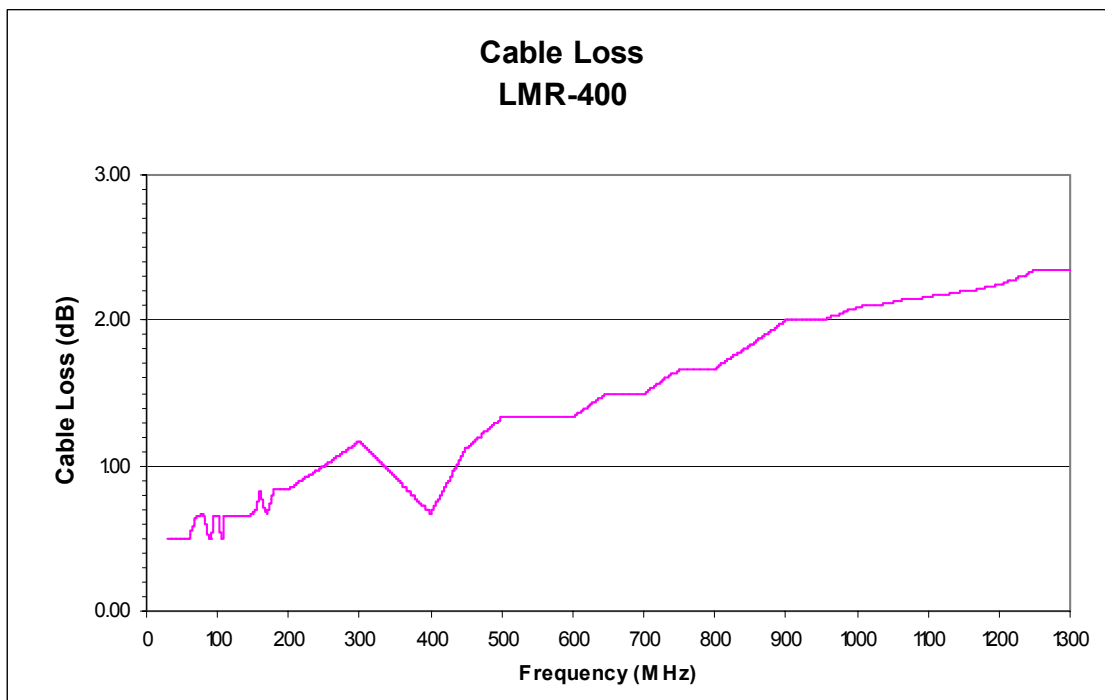
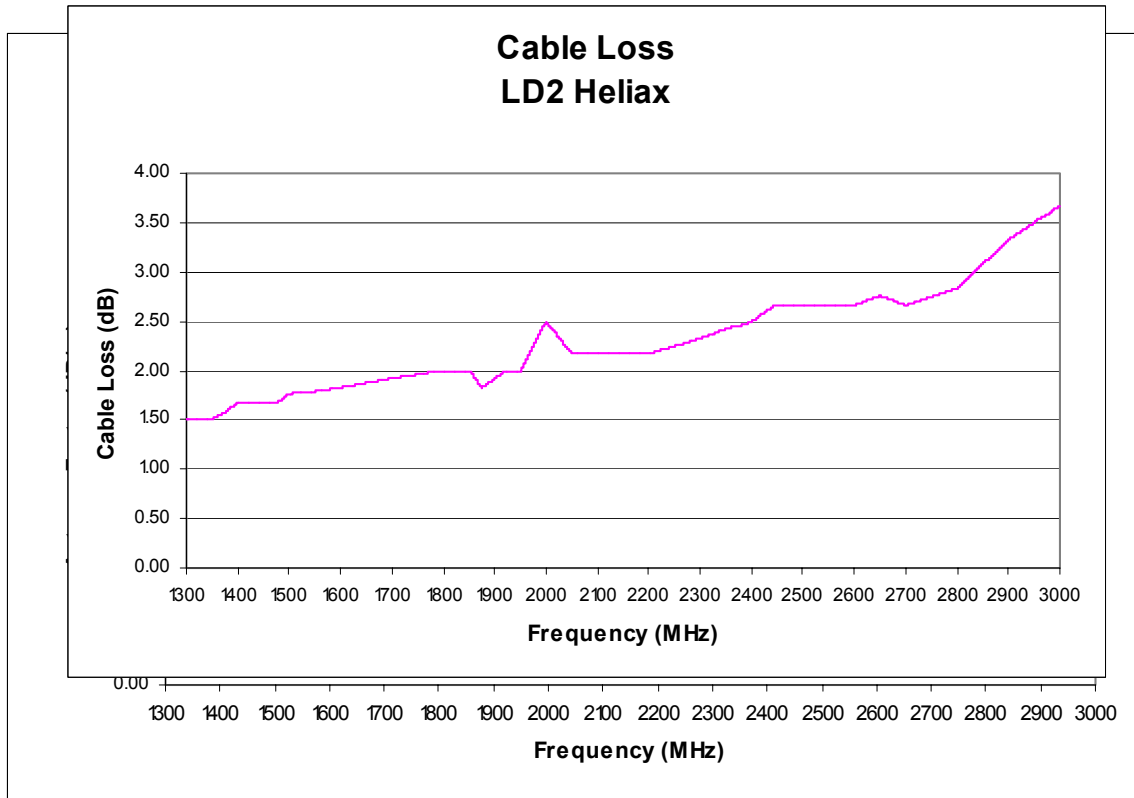

Appendix D

Survey Equipment

Hardware:

Measurement Devices:	Model Number	Calibration Date
Spectrum Explorer		March 2001
Vector Signal Analyzer	HP 89441A	July 12 / 1997
Narda Meter	8718	March 2000
Narda Safety Code 6 Probe	CN8722N	March 2000
Narda E-Field Probe	8760N	March 2000

Antennas:

Singer (150 kHz to 30 MHz)	92198-3	
Basic whip (30 MHz to 80 MHz)		June 2000
Rhode and Schwarz (80 MHz to 1300 MHz)	HK014	April 2001
Tecom (1300 MHz to 3000 MHz)	201031	April 2001

Auxiliary:

GPS Receiver
 Wooden Tripod
 GPIB Cable
 RF Connector Kit
 Digital Camera
 Inverter

Software:

HP VEE - Version 5.0
 Data Acquisition Software
 Microsoft Visual Basic - Version 6.0
 Spectrum Explorer data acquisition software
 Microsoft Visual C++ - Version 6.0
 Data analysis program
 MapInfo Professional - Version 6.0

Appendix E
Photographs of Various Antennas



Figure No. 06
Tecom 201031



Figure No. 07
Rhode and Schwarz HK014

Appendix F

List of Acronyms

DGSE - Directorate General of Spectrum Engineering

DGSE “facilitates Canadian industry access to spectrum and orbit resources through the ITU radio regulatory processes and international coordination and negotiations. They develop rules and procedures for the implementation of new radiocommunication and telecommunication services.”⁴

DEB Lab - Directorate of Engineering Bureau

The DEB Lab tests and certifies telecommunication and radiocommunication terminal equipment.

CRC - Communication Research Centre Canada

“Communication Research Centre Canada (CRC) has been dedicated to advanced communications R&D for over 30 years. Its research provides a technical basis for the development of regulations and standards in support of public policy. Key research areas include: radio sciences; terrestrial wireless; broadcast technologies; satellite communications systems; broadband network systems; and microelectronic and optical technologies. CRC has a strong tradition of technology transfer to industry and has been responsible for the creation of more than 60 companies. It operates an Innovation Centre to provide high-tech startups with access to its technologies, research expertise and unique laboratories.”⁵

Acton RSSC - Acton Regional Spectrum Services Centre

“RSSC Acton is active in many areas in Spectrum Surveillance and Management. This includes the collection of occupancy data, development and maintenance of remote monitoring systems, training of departmental staff and development of new systems to aid in the effective and efficient management of the radio frequency spectrum for all Canadians.”⁶

Mathews, K. New Year Operational Plan. April 2002.

Sources of Federal Government Information 2000-2001, http://infosource.gc.ca/Info_1/IC-OR-e.html

About RSSC, <ftp://rssc.ic.gc.ca/About%20RSSC/centre%20handout.pdf>

Appendix G**Sites Suggested by
City of Toronto Officials**

The following sites were suggested by City of Toronto officials:

Site #	Location
1	Bathurst / Bloor
15	Metro Hall Grounds
20	Yonge / St. Clair W.
21	Yonge / Wellesley St. E.
25	Bayview / York Mills
29	Don Mills / Lawrence
31	Highview / Wilson
32	Islington / Cordova
34	Jane / Eglinton
37	Leslie / Talwood Park
38	Leslie / York Mills
41	Roselawn Public School

Appendix H

Contact List

Ben Nguyen, P.Eng.
151 Yonge Street
Toronto, ON M5C 2W7
E-mail: nguyen.ben@ic.gc.ca

Sumesh Mohabeer, P.Eng.
126 Wellington St. W.
Aurora, ON L4G 2N9
E-mail: mohabeer.sumesh@ic.gc.ca

Vicky Lai
151 Yonge Street
Toronto, ON M5C 2W7
E-mail: lai.vicky@ic.gc.ca

Elisabeth Lander
151 Yonge Street
Toronto, ON M5C 2W7
E-mail: lander.elisabeth@ic.gc.ca

Appendix I

References

- Balanis, Constantine A., Antenna Theory Analysis and Design, Second Edition, John Wiley & Sons, Inc., 1997.
- Gailey, P. C., and R.A. Tell, “An Engineering Assessment of the Potential Impact of Federal Radiation Protection Guidance on the AM, FM, and TV Broadcast Services”, U.S. Environmental Protection Agency, April 1985.
- Hayt, Jr., William H., Engineering Electromagnetics, Fourth Edition, McGraw-Hill Book Company, 1981.
- Johnson, Richard C. and Jasik, Antenna Engineering Handbook, Second Edition, McGraw-Hill Book Company, 1984.
- Petersen, R. and P. Testagrossa, “Radio-Frequency Electromagnetic Fields Associated with Cellular-Radio Cell-Site Antennas”. Bioelectromagnetics, 13:527-542, 1992.
- Tell, Richard .A., “Engineering Services for Measurement and Analysis of Radiofrequency (RF) Fields”, Richard Tell Associates, Inc., Las Vegas, NV., June 1995.
- A Study on Electric Field Intensity Distribution in the Near-Field Region of PCS Base Station Antenna Installations, Industry Canada, Spectrum Management, Ontario Region, January 1999.
- Limits of Human Exposure to Radiofrequency Electromagnetic Fields at Frequency Range from 3 kHz - 300 GHz, Safety Code 6; Health Canada, Environmental Health Directorate, Health Protection Branch, Catalogue No. H46-2/99-237E, 1999.